

harman/kardon

STEREO
INTEGRATED
AMPLIFIER

PM655

owner's manual

harman/kardon PM655

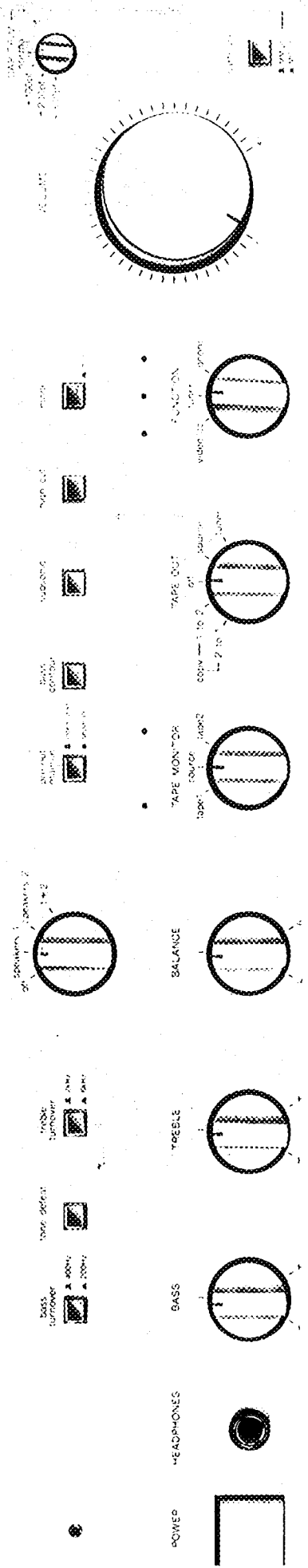

SPECIFICATIONS

Congratulations on your purchase of the Harman Kardon PM655 Stereo Integrated Amplifier.

In order to appreciate the full performance of this sophisticated unit, please be sure to read this owner's manual and use your integrated amplifier only in accordance with its instructions. Keep it in a safe place for future reference.

Power Output, RMS	: 60 watts per channel (both channels driven into 8 Ohms, 20—20,000Hz)
HCC (high instantaneous current capability)	: 45A
Power Bandwidth (at half rated output into 8 Ohms)	: 10Hz to 100,000Hz
Frequency Response (+0, -3dB)	: 0.2Hz to 150,000Hz
Damping Factor	: >65
Signal-to-Noise Ratio, IHF-A WTD (reference 1W output)	
Phono (MM)	: 79dB
Phono (MC)	: 77dB
Video/CD, Tuner, Tape	: 80dB
Input Sensitivity/Impedance	
Phono (MM)	: 2.2mV/47k Ohms and 125pF
Phono (MC)	: 120 μ V/56 Ohms
Video/CD, Tuner, Tape	: 135mV/22k Ohms
Main-in	: 0.8V/22k Ohms
Phono Overload	
MM	: 220mV
MC	: 12mV
Tone Control Characteristics	
Bass Turnover Frequency	: 200Hz/400Hz
Treble Turnover Frequency	: 2kHz/6kHz
Filters	
Subsonic	: 15Hz, 6dB/Octave
High Cut	: 6kHz, 6dB/Octave
Bass Contour	
Boost (at 50Hz)	: +10dB
Phase Shift (300—20,000Hz)	: <5°
Dimensions (W x H x D)	: 17-1/2" x 5-5/16" x 15-11/16" (443 x 134 x 398 mm)
Weight	: 22lbs. 11oz. (10.3kg)
Power Supply	: AC 120V, 60Hz
Power Consumption	: 400W

All specifications and features subject to change without notice.



CAUTION
RISK OF ELECTRIC SHOCK
DO NOT OPEN



CAUTION: TO REDUCE THE RISK OF ELECTRIC SHOCK, DO NOT REMOVE COVER (OR BACK). NO USER-SERVICEABLE PARTS INSIDE. REFER SERVICING TO QUALIFIED SERVICE PERSONNEL.



The lightning flash with arrowhead symbol, within an equilateral triangle, is intended to alert the user to the presence of uninsulated "dangerous voltage" within the product's enclosure that may be of sufficient magnitude to constitute a risk of electric shock to persons.



The exclamation point within an equilateral triangle is intended to alert the user to the presence of important operating and maintenance (servicing) instructions in the literature accompanying the appliance.

WARNING: TO REDUCE THE RISK OF FIRE OR ELECTRIC SHOCK, DO NOT EXPOSE THIS APPLIANCE TO RAIN OR MOISTURE.

CAUTION: TO PREVENT ELECTRIC SHOCK, DO NOT USE THIS (POLARIZED) PLUG WITH AN EXTENSION CORD, RECEPTACLE OR OTHER OUTLET UNLESS THE BLADES CAN BE FULLY INSERTED TO PREVENT BLADE EXPOSURE.

ATTENTION: POUR PREVENIR LES CHOCS ELECTRIQUES NE PAS UTILISER CETTE FICHE POLARISEE AVEC UNE RALLONGE. UNE PRISE DE COURANT OU UNE AUTRE SORTIE DE COURANT, SAUF SI LES LAMES PEUVENT ETRE INSEREES A FOND SANS EN LAISSER AUCUNE PARTIE A DECOUVERT.

This manual applies to champagne gold and black versions with this model PM655.

■HCC (High-instantaneous Current Capability)

Recent studies have shown that while reproducing dynamic music signals the instantaneous impedances of nearly all loud-speakers drop to less than one third of the nominal ratings. These low instantaneous impedances typically require 3 to 6 times more current than an 8 Ohm resistive load. Reduced dynamic range and increased distortion will result if the amplifier cannot provide these higher currents. For this reason, the PM655 was designed to provide 45 amperes of instantaneous current.

■Ultrawide Bandwidth

The bandwidth of this unit is exceptionally wide and independent of negative feedback. This improves transient accuracy and phase linearity.

■Low Negative Feedback

This unit has been designed to have low distortion and wide bandwidth without high negative feedback. This further improves its dynamic accuracy.

■Dual RIAA Phono Equalization

The phono section employs Harman Kardon's unique dual RIAA equalization circuitry. RIAA equalization is used in both the open-loop and closed-loop signal path (with and without negative feedback). This permits the application of constant low-level negative feedback throughout the audio range.

■Discrete Component Circuitry

In order to achieve the above goals, all discrete electronic circuitry has been employed. All available integrated circuits could not provide this high level of performance.

■Sophisticated Electronic Protection

Harman Kardon engineers developed a unique protection system that permits high instantaneous current to be driven into speaker systems but protects the amplifier from short-circuited or damaged speakers and wires. This protection system in no way limits amplifier output voltage or current during music reproduction, and therefore has no negative effect on sound quality.

■Moving Coil Cartridge Amplifier

A high sensitivity, low noise amplifier is provided. This permits the direct input of most moving coil cartridges.

■Capacitance Trim Selector

This feature enables precise impedance matching between moving magnet type cartridges and the phono circuitry. The widest, flattest frequency response possible can be obtained from any high quality phono cartridge.

■Pre-out/Main-in Switch

This feature allows independent use of the preamplifier and main (power) amplifier sections. With this switch in the "integrated" position, the preamplifier section is internally connected to the main (power) amplifier. By depressing this switch to the "separate" position, the preamplifier output and main (power) amplifier input jacks on the rear panel become active.

■Bass Contour

Bass contour is an exclusive Harman Kardon feature which provides two major benefits: it can equalize and restore the low frequency response of small loud-speakers, and it can be used in place of conventional loudness contour. But unlike conventional bass boost circuits, Harman Kardon's bass contour also includes a phase correction circuit that maintains clear, natural sound.

Always Use at 120V AC

This unit is designed for operation with 120V AC. Connect only to domestic AC outlets. Never connect the unit to an outlet supplying a higher voltage. This may create a fire hazard.

Handle the Power Cord Gently

- Do not disconnect the plug from the AC outlet by pulling the cord; always pull the plug itself. Pulling the cord may break the wire.
- If you do not intend to use your unit for any considerable length of time, disconnect the plug from the AC outlet.
- Do not place furniture or other heavy objects on the cord, and avoid dropping heavy objects on it. Also do not make a knot in the power cord. Not only may the cord be damaged, it can also cause a short circuit and a consequent fire hazard.

Place of Installation

Place your unit on a firm and level surface. Avoid installing your unit under the following conditions:

- ▶ Moist or humid places.
- ▶ Places exposed to direct sunlight or close to heating equipment.
- ▶ Extremely cold locations such as those in the direct draft from an air conditioner.
- ▶ Places subject to excessive vibration or dust.
- ▶ Poorly ventilated places.

Do not cover the ventilation slots on the top of the unit. This will cause the temperature inside the unit to rise, which can eventually effect the reliability of your unit.

Moving the Unit

Before moving the unit, be sure to unplug the power cord from the AC outlet and disconnect the interconnection cords to other units.

Do Not Open the Cabinet

To prevent fire or shock hazard, do not tamper with internal components for inspection or maintenance. Harman Kardon does not guarantee against performance degradation resulting from any modification.

If water, a hairpin or wire accidentally enters the unit, immediately unplug the power cord from the AC outlet to prevent shock and consult an authorized Harman Kardon service station. If you use the unit under this condition, it may cause a fire or shock hazard.

Cleaning

When the unit gets dirty, wipe it with a soft dry cloth. If necessary, wipe it with a soft cloth dampened with mild soapy water and then wipe with a dry cloth.

Never use benzine, thinner, alcohol or other volatile agent, and avoid spraying an insecticide near the unit.

Connecting Other Components

Carefully connect the plugs to the left and right channel jacks. Push the plugs in all the way. Poor setting of the plugs tends to cause hum or intermittent sound and may damage the speakers.

NOTE: While you are connecting this unit to the rest of your high fidelity system, please unplug the power cord, disconnecting not only this unit but all the components, from the AC outlet.

Do not interwind the connection wires with the power cord. If interwound, the sound quality may be degraded.

The AC convenience receptacles on the rear panel can be used for supplying power to a tuner, turntable, tape deck or other low power component. The SWITCHED receptacles have a combined power capacity of 160 watts. The UNSWITCHED receptacle has a power capacity of 200 watts. Check the component's owner's manual to find its power requirement.

SWITCHED: The power to this receptacle is turned on and off by this unit's power switch.

UNSWITCHED: The power to this receptacle is independent of this unit's power switch.

Connecting Speakers

Connect the speaker wires carefully to the speaker terminals on the rear panel so as not to mistake the left and the right channels or reverse the speaker polarities (+ and -).

Use sufficiently thick wire (18 gauge for short lengths, 16-12 gauge for longer lengths). It is recommended to use color-coded wire for easy polarity identification. Speaker wires should be as short as possible, and the left and the right channel wires should be the same length.

1. Remove about 3/4 inch (20 mm) of insulation from the end of each wire and twist the strands of each end.

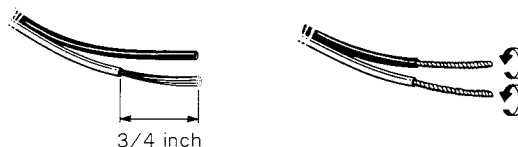

2. After making sure of the correct channel and polarity, loosen the SPEAKER SYSTEM terminal knob and insert the conductor directly into the recess at the upper-left of the terminal. Then tighten the terminal knob, and the end of speaker wire is automatically wound around the terminal.

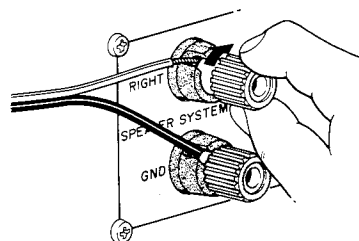

CAUTION: Two speaker systems can be connected to this unit. The minimum speaker impedance should be 4 Ohm when only one speaker system is connected. When two speaker systems are connected, care should be taken that net impedance does not become less than 4 Ohm.

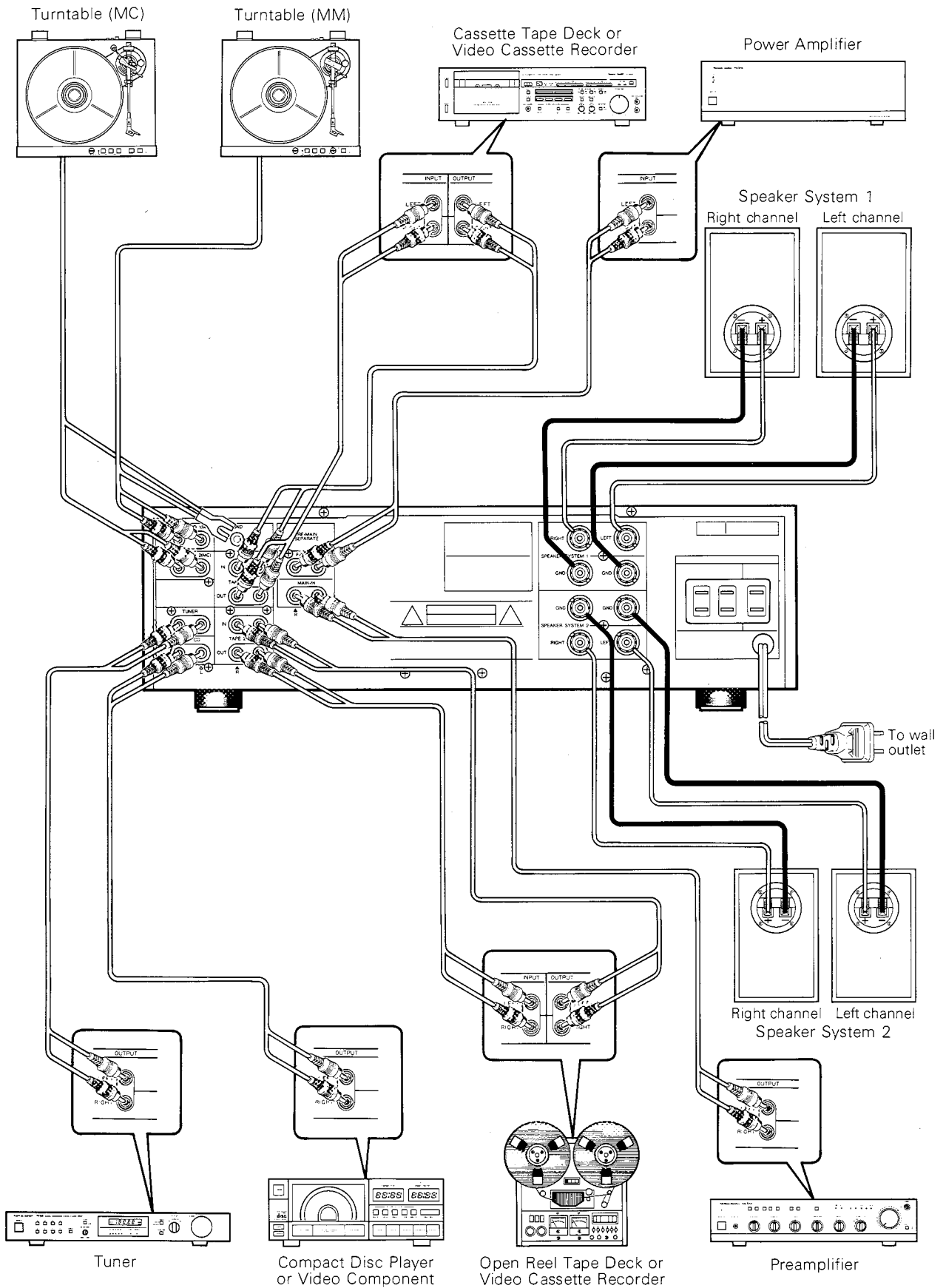

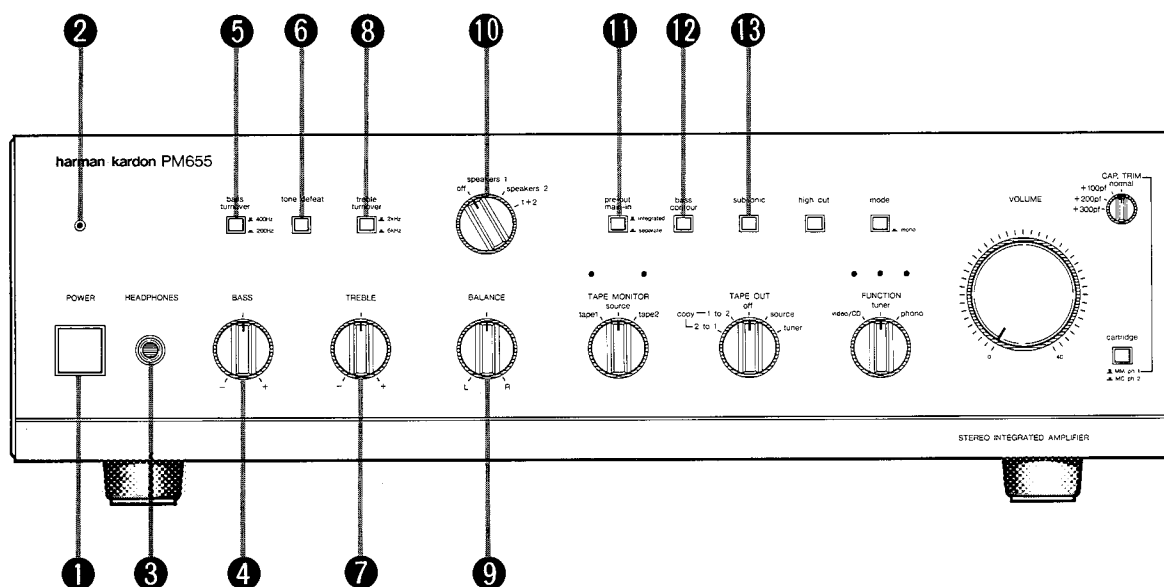

1 POWER SWITCH (POWER)

Pressing this switch will turn on the power and the POWER indicator lights up. Press the switch again to turn the power off.

2 POWER INDICATOR

When the POWER switch is pressed, the POWER indicator lights up in red.

3 HEADPHONE JACK (HEADPHONES)

Stereo headphones with a standard 1/4 inch plug can be connected to this jack. When the SPEAKER selector is in the "off" position, sound can still be obtained via the headphone jack.

4 BASS CONTROL KNOB (BASS)

This knob controls the low frequency sound level. Turn it clockwise to boost or counterclockwise to reduce the low frequency sound level.

5 BASS TURNOVER SELECTOR (bass turnover)

This switch is used to select the bass turnover frequency. By pressing this switch to set in the "200Hz" position, the low frequency sound below 200Hz is controlled by the BASS control knob. By releasing this switch to set to the "400Hz" position, the low frequency sound below 400Hz is controlled by the BASS control knob.

6 TONE DEFEAT SWITCH (tone defeat)

This switch is used to make the frequency characteristic flat by internally bypassing the tone control circuitry. Set this switch to the OFF position (button out) when you want to use the tone control knobs.

7 TREBLE CONTROL KNOB (TREBLE)

This knob controls the high frequency sound level. Turn it clockwise to boost or counterclockwise to reduce the high frequency sound level.

8 TREBLE TURNOVER SELECTOR (treble turnover)

This switch is used to select the treble turnover frequency. By pressing this switch to set in the "6kHz" position, the high frequency sound above 6kHz is controlled by the TREBLE control knob. By releasing this switch to set to the "2kHz" position, the high frequency sound above 2kHz is controlled by the TREBLE control knob.

9 BALANCE CONTROL KNOB (BALANCE)

This knob is used to balance the left and the right channels. Usually, it is set at the center. Turn it to the left or right to balance the sound if it seems unbalanced from the speakers or the headphones.

10 SPEAKER SELECTOR

This selector is used to select the desired speaker system(s).
off : Select this position to listen to sound via the headphone with no sound from the speaker system(s).
speakers 1 : Select this position to actuate the speaker system connected to the SPEAKER SYSTEM 1 terminal.
speakers 2 : Select this position to actuate the speaker system connected to the SPEAKER SYSTEM 2 terminal.
1 + 2 : Select this position to actuate simultaneously the two speaker systems connected to the SPEAKER SYSTEM 1 and 2 terminals respectively.

11 PRE-OUT/MAIN-IN SWITCH (pre-out main-in)

Usually this switch is kept in the "integrated" position. By depressing this switch to the "separate" position, the preamplifier and power amplifier sections are separated from each other for their independent function. To use the preamplifier section independently, connect the input jacks of the other power amplifier to the PRE-OUT jacks on the rear panel. To use the power amplifier section independently, connect the output jacks of the other preamplifier to the MAIN-IN jacks on the rear panel.

12 BASS CONTOUR SWITCH (bass contour)

This switch activates a unique low frequency equalization circuit that provides full, natural sound from small speakers that are normally deficient in the bass region. It can also be used in place of conventional loudness compensation.

13 SUBSONIC FILTER SWITCH (subsonic)

When playing the turntable, this filter switch is used to reduce subsonic frequencies, which may excessively vibrate the speaker cones or turntable and cause feedback.

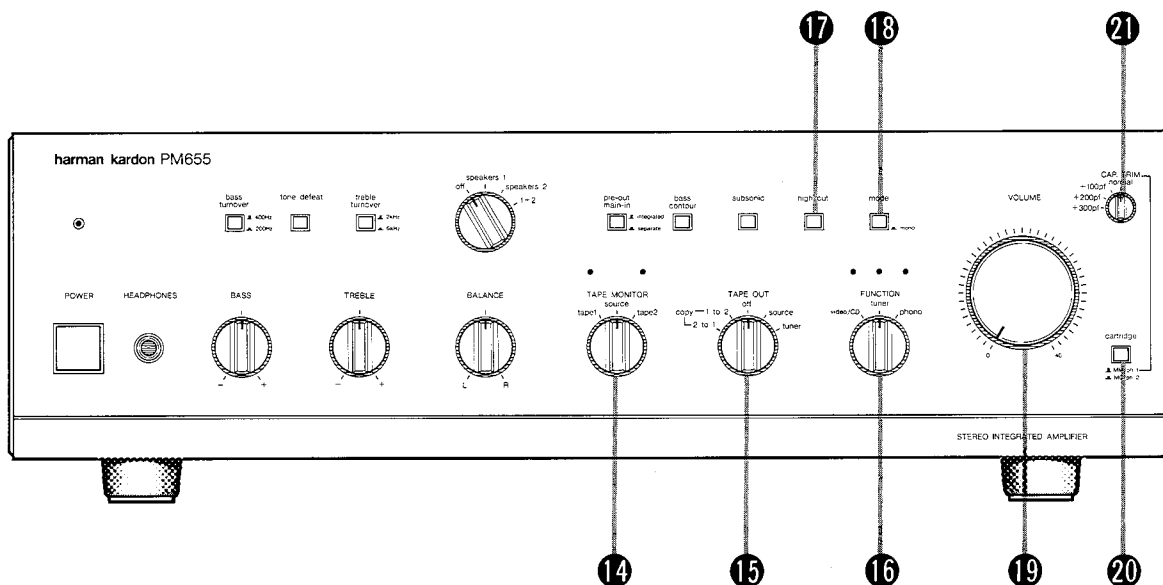

14 TAPE MONITOR SELECTOR (TAPE MONITOR)

This selector is used when listening to a tape or monitoring the sound during recording. The tape monitor indicator lights up in red corresponding to the selector position.

tape 1 : Select this position to play a tape or to monitor the sound during recording on the tape deck connected to the TAPE 1 jacks.

source : Select this position to listen to a program source other than a tape.

tape 2 : Select this position to play a tape or to monitor the sound during recording on the tape deck connected to the TAPE 2 jacks.

NOTE: The TAPE 1 and/or TAPE 2 jacks on the rear panel can also be used to record and playback audio signals with video cassette recorder(s).

The VIDEO/CD jacks can be used to play audio signals from a video disc player or video cassette recorder.

15 TAPE OUT SELECTOR (TAPE OUT)

This selector is used for recording from another input on the tape deck(s) connected to the TAPE 1 and/or TAPE 2 jacks, for dubbing between two tape decks or for recording another sound source independent of the FUNCTION selector.

tuner : In this position, the tuner signal is available at the TAPE 1 and TAPE 2 OUTPUT jacks regardless of the position of the FUNCTION selector. This permits recording the tuner signal on the tape deck(s) connected to TAPE 1 and/or TAPE 2 jacks while using the preamplifier and power amplifier sections in another mode (listening to phono, video, CD or other sources, for example).

source : Select this position to record the program source selected by the FUNCTION selector in either or both of the two tape decks connected to the TAPE 1 and TAPE 2 jacks.

off : Select this position to prevent the degradation of sound quality when recording function is not operated.

copy-2 to 1 : Select this position to duplicate the tape in the deck connected to the TAPE 2 jacks onto the tape in the deck connected to the TAPE 1 jacks.

copy-1 to 2 : Select this position to duplicate the tape in the deck connected to the TAPE 1 jacks onto the tape in the deck connected to the TAPE 2 jacks.

16 FUNCTION SELECTOR (FUNCTION)

This selector is used to select a program source other than a tape.

video/CD : Select this position to listen to the sound from the video component, the compact disc player or other component connected to the VIDEO/CD jacks.

tuner : Select this position to listen to an FM or AM broadcast from the stereo tuner connected to the TUNER jacks.

phono : Select this position to listen to a disc played on the turntable connected to the PHONO 1 (MM) or PHONO 2 (MC) jacks.

Each function indicator illuminates in red corresponding to the setting of the FUNCTION selector.

17 HIGH CUT FILTER SWITCH (high cut)

This switch is pressed to cut off high frequency noise such as disc scratches or tape hiss.

18 MODE SWITCH (mode)

This switch is used to combine the left and right channels and create a mono signal.

19 VOLUME CONTROL KNOB (VOLUME)

This knob controls the sound level. Turning clockwise increases the sound volume, and turning counterclockwise decreases it. Set this knob at a minimum level before turning the power on or changing the sound source to protect the speakers from being damaged by a sudden high level sound.

20 CARTRIDGE SELECTOR (cartridge)

This switch selects the gain and input impedance of the phono input circuitry to match the type of phono cartridge used. The phono 1 circuitry is optimized for MM (Moving Magnet) type cartridges and the phono 2 circuitry for MC (Moving Coil) type cartridges. Be sure to connect the turntable to the appropriate PHONO input jacks, and to select that input with this selector switch.

21 CAPACITANCE TRIM SELECTOR (CAP. TRIM)

This selector is used to select the optimum load capacitance for the MM cartridge used in the turntable connected to the PHONO 1 (MM) jacks.

Listening to a Record (Disc)

1. Turn the VOLUME control knob to the minimum level and press the POWER switch. The POWER indicator lights up.
2. Set the SPEAKER selector for the desired speaker system(s).
3. Set the FUNCTION selector to the "phono" position and the phono function indicator will light up.
4. Set the CARTRIDGE selector to the "MM ph.1" position when a turntable with a MM (moving magnet) cartridge connected to the PHONO 1 (MM) jacks is to be used and to the "MC ph.2" position for a turntable with a MC (moving coil) cartridge connected to the PHONO 2 (MC) jacks.
5. When an MM cartridge is used, set the CAP. TRIM selector to its optimum load capacitance according to the table below.
6. Set the TAPE MONITOR selector to the "source" position.
7. Activate your turntable and place the stylus on the record (disc).
8. Turn the VOLUME control knob clockwise to increase the sound volume to the desired level.
9. If the disc has a large warp, press the SUBSONIC filter switch.
10. Adjust the BASS and TREBLE control knobs to obtain the desired tone.
11. Activate the BALANCE control knob, BASS TURNOVER, TREBLE TURNOVER, TONE DEFEAT, BASS CONTOUR, HIGH CUT filter, or MODE switch if necessary.

NOTE: If you hear a hum at average listening levels, turn the POWER switch off and check to see that the phono and the ground connections are secure. Depending on the cartridge type used, less hum may be created without the ground connection.

When only one turntable is used, be sure to insert the attached short-pin plug into the PHONO 1 (MM) or PHONO 2 (MC) jacks that is not being used.

Adjusting the Capacitance Trim

Each cartridge has a specified load capacitance into which it performs best. To determine the capacitive load on the cartridge, the capacitance of the amplifier's phono input circuitry and the capacitance of the turntable's tonearm and output cord must be added. Often, this amount is less than that required by the cartridge. The capacitance trim feature allows you to add 100pF, 200pF or 300pF to the normal amount, so that nearly all cartridges can be accommodated.

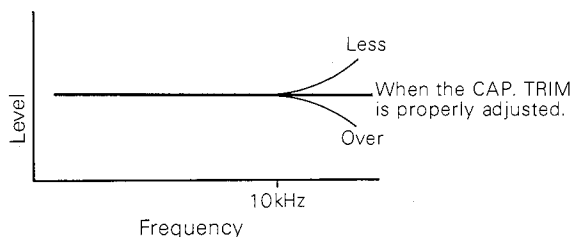

Select the optimum load capacitance for your MM cartridge of turntable connected to the PHONO 1 (MM) jacks by referring to the table below.

Rec. Cartridge Load*	CAP. TRIM Position
200pF or less	normal
200 — 300pF	+100pf
300 — 400pF	+200pf
400pF or more	+300pf

*Consult the phono cartridge owner's manual to find its recommended capacitive load.

Listening to Broadcasts

1. Turn the VOLUME control knob to the minimum level and press the POWER switch. The POWER indicator lights up.
2. Set the SPEAKER selector for the desired speaker system(s).
3. Set the FUNCTION selector to the "tuner" position, and the tuner function indicator will light up.
4. Set the TAPE MONITOR selector to the "source" position.
5. Activate the tuner and tune to broadcast frequency.
6. When the monaural broadcast is received, press the MODE switch to the "mono" position.
7. When the desired station is selected, advance the VOLUME control knob to a comfortable level and adjust the BASS and TREBLE control knobs as desired.
8. Activate the BALANCE control knob, BASS TURNOVER, TREBLE TURNOVER or BASS CONTOUR switch if necessary.

Listening to the Video/CD Input Source

To listen to a video component, compact disc player or other component:

1. Turn the VOLUME control knob to the minimum level and press the POWER switch. The POWER indicator lights up.
2. Set the SPEAKER selector for the desired speaker system(s).
3. Set the FUNCTION selector to the "video/CD" position and the video/CD function indicator will light up.
4. Set the TAPE MONITOR selector to the "source" position.
5. Activate the component connected to the VIDEO/CD jacks.
6. Advance the VOLUME control knob to a comfortable level and adjust the BASS and TREBLE control knobs as desired.
7. Activate the BALANCE control knob, BASS TURNOVER, TREBLE TURNOVER, TONE DEFEAT, BASS CONTOUR or MODE switch if necessary.

Tape Recording

Recording from a program source (FM/AM broadcast, turntable or components connected to the VIDEO/CD jacks) on a tape deck connected to the TAPE 1 and/or TAPE 2 jacks:

1. Turn the VOLUME control knob to the minimum level and press the POWER switch. The POWER indicator lights up.
2. Set the SPEAKER selector for the desired speaker system(s).
3. Select the desired program source with the FUNCTION selector. The function indicator lights up to indicate the program source selected.
4. Set the TAPE OUT selector to the "source" position.
5. Set the TAPE MONITOR selector to the "source" position.
6. Advance the VOLUME control knob to a comfortable level.
7. If the program source mode is monaural, press the MODE switch to the "mono" position according to the mono program source.
8. Start recording by activating the tape deck(s) connected to the TAPE 1 and/or TAPE 2 jacks. The source sound can be listened to from the speakers or headphone.
9. To monitor the sound being recorded, set the TAPE MONITOR selector to the "tape 1" or "tape 2" position according to the tape deck being recorded. The tape monitor indicator will light up, indicating the monitoring state.

NOTE: Recording onto the tape deck is carried out directly from the program source without being influenced by the volume, balance, bass and treble controls, bass and treble turnovers, tone defeat, bass contour, subsonic and high cut filter switches of this unit.

Air check can be made while listening to other program source.

1. Turn the VOLUME control knob to the minimum level and press the POWER switch. The POWER indicator lights up.
2. Set the SPEAKER selector for the desired speaker system(s).
3. Set the FUNCTION selector to the "tuner" position.
4. Set the TAPE MONITOR selector to the "source" position.
5. Activate the tuner and tune to broadcast frequency.
6. Set the TAPE OUT selector to the "tuner" position.
7. Start recording by activating the tape deck(s) connected to the TAPE 1 and/or TAPE 2 jacks. The broadcast sound can be listened to from the speakers.
8. Select the desired program source with FUNCTION selector. The new sound source will be heard from the speakers.

Tape Playback

1. Turn the VOLUME control knob to the minimum level and press the POWER switch. The POWER indicator lights up.
2. Set the SPEAKER selector for the desired speaker system(s).
3. Set the TAPE OUT selector to the "off" position.
4. Set the TAPE MONITOR selector to the "tape 1" or "tape 2" position corresponding to the tape deck to be played. The tape 1 or 2 monitor indicator will light up.
5. Insert a recorded tape in the tape deck and set the tape deck in the playback mode.
6. Advance the VOLUME control knob to a comfortable level and adjust the BASS and TREBLE control knobs as desired.
7. Activate the BALANCE control knob, BASS TURNOVER, TREBLE TURNOVER, TONE DEFEAT, BASS CONTOUR, HIGH CUT filter or MODE switch if necessary.

Tape Dubbing

Two tape decks can be connected to this unit and dubbing can be done from either tape deck to the other.

Dubbing from tape deck 1 to tape deck 2

1. Turn the VOLUME control knob to the minimum level and press the POWER switch. The POWER indicator lights up.
2. Set the SPEAKER selector for the desired speaker system(s).
3. Set the TAPE OUT selector to the "copy-1 to 2" position.
4. If the program source mode is monaural, press the MODE switch to the "mono" position.
5. After setting the tape deck 1 connected to the TAPE 1 jacks for playback, and the tape deck 2 connected to the TAPE 2 jacks for recording, dubbing will begin.
6. To monitor the sound being played, set the TAPE MONITOR selector to the "tape 1" position. To monitor the sound being recorded, set the TAPE MONITOR selector to the "tape 2" position.

Dubbing from tape deck 2 to tape deck 1

1. Set the TAPE OUT selector to the "copy-2 to 1" position.
2. Dubbing will begin by setting the tape deck 2 connected to the TAPE 2 jacks to playback and the tape deck 1 connected to TAPE 1 jacks to record.

Another program source (phono, tuner, video/CD) can be listened to during dubbing, with no effect on the dubbing quality.

1. Set the TAPE MONITOR selector to the "source" position.
2. Select the desired program source with the FUNCTION selector.

Most of the problems consumers have with their high fidelity system are due to incorrect operation. If this unit does not operate as you intended, first check the items in the

following checklist. Also check other related components such as the tuner, turntable, speakers and other electrical equipment you use with this amplifier.

Problem	Cause	Remedy
The POWER indicator does not light up when the POWER switch is pressed.	<ul style="list-style-type: none"> •The power cord is not plugged in. 	<ul style="list-style-type: none"> •Plug in the power cord securely.
The POWER indicator lights up, but no sound is heard.	<ul style="list-style-type: none"> •The TAPE MONITOR selector is in the "tape 1" or "tape 2" position. •The FUNCTION selection was not made properly. •The SPEAKER selector is in the "off" position. •The PRE-OUT/MAIN-IN switch is pressed to the "separate" position. •The speaker wires are disconnected or broken. 	<ul style="list-style-type: none"> •Set the TAPE MONITOR selector to the "source" position. •Set the FUNCTION selector to the proper position for the desired program source. •Set the SPEAKER selector to the position of your desired speaker system(s). •Release the PRE-OUT/MAIN-IN switch to the "integrated" position. •Check the speaker wires and connect them correctly.
Sound is not heard from the speaker system on one side.	<ul style="list-style-type: none"> •The connection of a speaker wires are incorrect or incomplete. •The connection wires to other equipment are disconnected. •The BALANCE control knob is turned to either the extreme right or the left position. 	<ul style="list-style-type: none"> •Check the speaker wires for disconnection or breaking and reconnect them correctly. •Check the wires for disconnection and connect them correctly. •Set the mark on the BALANCE control knob to the centre position.
Tone control is not functioning.	<ul style="list-style-type: none"> •The TONE DEFEAT switch is depressed. 	<ul style="list-style-type: none"> •Repress the TONE DEFEAT switch (button out).
When listening to stereo sound, the left and right sounds are reversed.	<ul style="list-style-type: none"> •The left and right speaker wires are reversed. •The left and right wires connected to other equipment are reversed. 	<ul style="list-style-type: none"> •Check the speaker wires and connect them correctly. •Check the wires to other equipment and connect them correctly.
When playing to a turntable, a low-pitched noise ("hum" or "buzz") is heard.	<ul style="list-style-type: none"> •The ground wire of the turntable is disconnected. •The connections of the turntable wires are incorrect or incomplete. 	<ul style="list-style-type: none"> •Make the ground wire connection correctly. •Insert the turntable wires into the PHONO jacks of this unit securely.

TROUBLESHOOTING CHECKLIST

Problem	Cause	Remedy
When increasing the volume level while playing a turntable, an undesirable prolonged sound (howling) is heard.	<ul style="list-style-type: none"> •“Howling” is created by the speakers and turntable. •Too much low frequency sound is present. 	<ul style="list-style-type: none"> •Place the speakers further away from the turntable. •Place the turntable on a more solid surface. •Decrease the setting of the BASS control knob and/or turn off the BASS CONTOUR switch. •Turn on the SUBSONIC filter switch.
Sound quality is poor.	<ul style="list-style-type: none"> •Input components have not been set up correctly. •Tone control is not proper. 	<ul style="list-style-type: none"> •Check the antenna of the tuner, cartridge of the turntable, or head of the tape deck, etc. and make corrections as needed. •Adjust the BASS and/or TREBLE control knobs to obtain a desired tone.